

MONTAJ KILAVUZU

adedto
Mobilya Çözüm

KESB SIFONYER

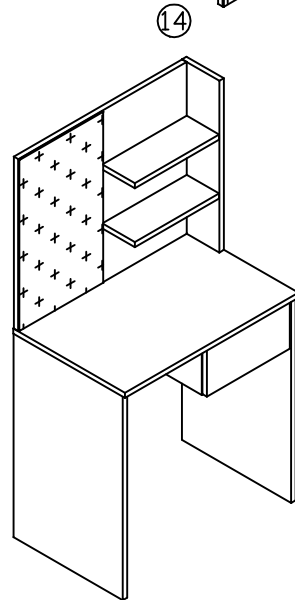
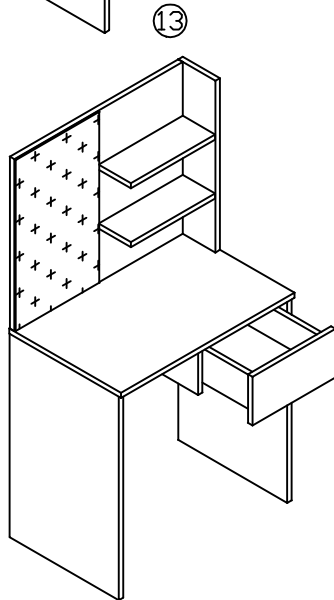
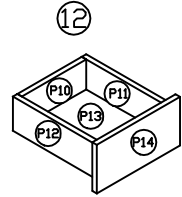
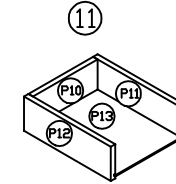
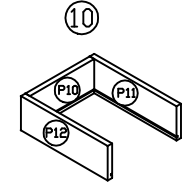
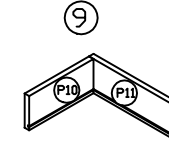
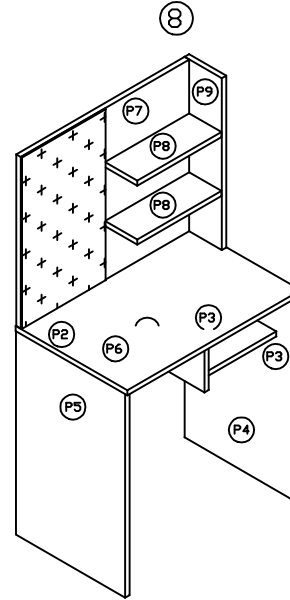
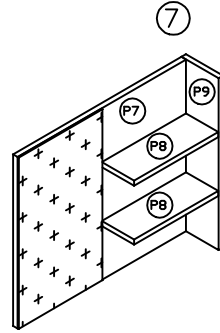
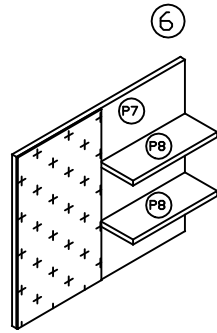
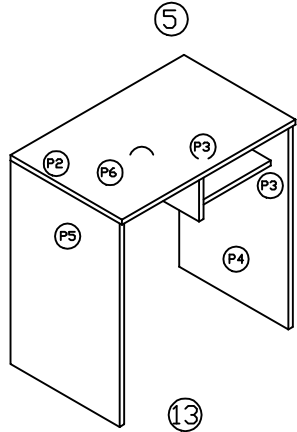
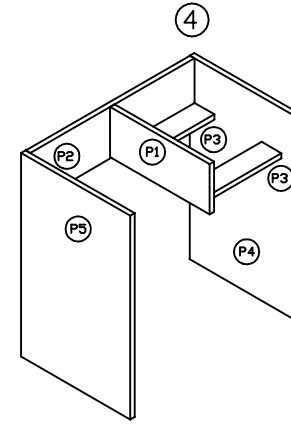
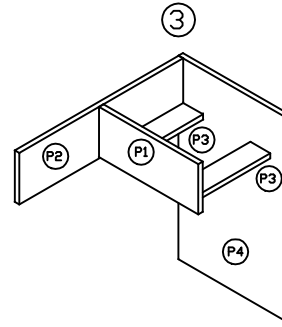
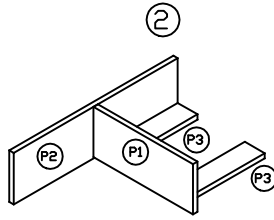
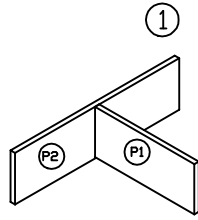
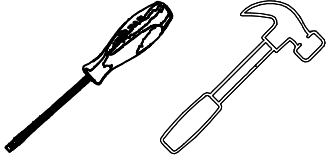

6. ASAMADA ÖNCE ÜST RAFI
DAHA SONRA ALT RAFI
TAKINIZ.

8. ASAMADA ÜST BÖLÜM İLE
ALT BÖLÜMÜ BİRLESTİRİNİZ

9-12. ASAMALARDA DETAYDA GÖSTERİLDİĞİ
GİBİ ÇEKMECEYİ TOPLAYINIZ. TOPLADIGINIZ
ÇEKMECEYİ MASADAKİ YERINE TAKINIZ.